



PL



ODBOJNICE PRZEMYSŁOWE - 2025 -

## Elektron Obróbka metalu

Specjalizujemy się w produkcji elementów w których przeważającym materiałem jest stal. Nasze usługi wykraczają poza rynek polski, obejmując Europę i inne regiony świata.

# PRDOUKCJA NA ZAMÓWIENIE ODBOJNICE PRZEMYSŁOWE

ELEKTRON SP. Z O.O.

# O NAS

## Kompleksowe wykonanie projektów na podstawie koncepcji klienta.

Jesteśmy firmą świadczącą kompleksowe usługi w zakresie obróbki metali. Oferujemy zróżnicowany zakres usług w zakresie obróbki metali, w tym produkcję mebli, wyposażenia sklepów i konstrukcji stalowych. Możemy stać się Twoim zaufanym dostawcą usług produkcyjnych.

### Certyfikaty

Jakość wykonania potwierdza doświadczenie, nowoczesny park maszyn oraz certyfikaty. Przechodzimy coroczne audyty przeprowadzane przez zewnętrzne jednostki certyfikujące. Aby spełnić wymagania rynku ciągle doszkalamy nasz personel oraz poszerzamy naszą wiedzę. Jesteśmy otwarci na współpracę w zakresie realizacji nawet najbardziej skomplikowanych projektów.



**EN 1090-1+A1**

LL-C (Certification)



**EN ISO 3834-2**

LL-C (Certification)



**ISO 9001**

LL-C (Certification)



### DOŚWIADCZENIE

Elektron sp. z o.o. posiada 7-letnie doświadczenie rynkowe w zakresie produkcji elementów stalowych i łączenia ich z materiałami niemetalowymi.



### KOMPLEKSOWA OBSŁUGA

Kompleksowa realizacja zlecenia, od rozpoczęcia do zakończenia.



### ZAPLECZE I PARK MASZYN

Inwestujemy w doświadczony personel, nowoczesny sprzęt i technologie.



### ORGANIZACJA I KULTURA PRACY

Stawiamy na wysoką organizację pracy aby dostarczać produkty wysokiej jakości minimalizując przy tym zbędne koszty. Naszym celem jest oferowanie naszym klientom korzystnej dla obu stron współpracy.

## Elektron sp. z o.o.

**Adres:** Sulistrowa 33, 38-462 Sulistrowa,

Poland

**Email:** [biuro@web-elektron.pl](mailto:biuro@web-elektron.pl)

**Telefon:** (+48) 13 307 0303

**NIP:** PL6842640074

**REGON:** 360939126

**KRS:** 0001022315



[webelektron.pl](http://webelektron.pl)

## W OFERCIE

- Odbojnice słupowe
- Odbojnice liniowe
- Odbojnice przypodłogowe
- Barierki techniczne
- Odbojnice narożne
- Odbojnice w kształcie litery U
- Ochrony kolumn
- Ograniczniki przypodłogowe
- Osłony regałów
- Naprowadzacz kół
- Ograniczniki wysokości

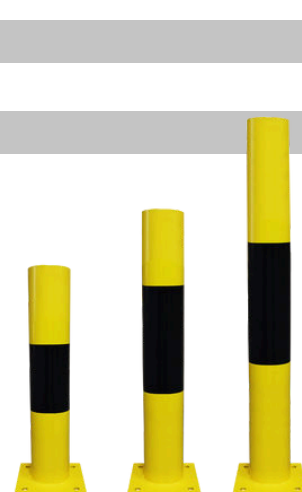

# OFERUJEMY SZEROKI WYBÓR ODBOJNIC

Zapewniamy kompleksową obsługę projektów, która obejmuje każdy etap, od koncepcji i produkcji po dostawę. Naszym celem jest oferowanie naszym klientom najlepszych możliwych rozwiązań w zakresie produkcji, popartych wiedzą branżową i najwyższą jakością.



**ODBOJNICE SŁUPOWE**



**ODBOJNICE LINIOWE**



**BARIERKI TECHNICZNE**



**ODBOJNICE NAROŻNE**



**ODBOJNICE W KSZTAŁCIE  
LITERY U**



**OSŁONY KOLUMN**



**OSŁONY REGAŁÓW**



**OGRANICZNIKI  
PRZYPODŁOGOWE**



**OGRANICZNIKI  
WYSOKOŚCI**



**NAPROWADZACZE KÓŁ**

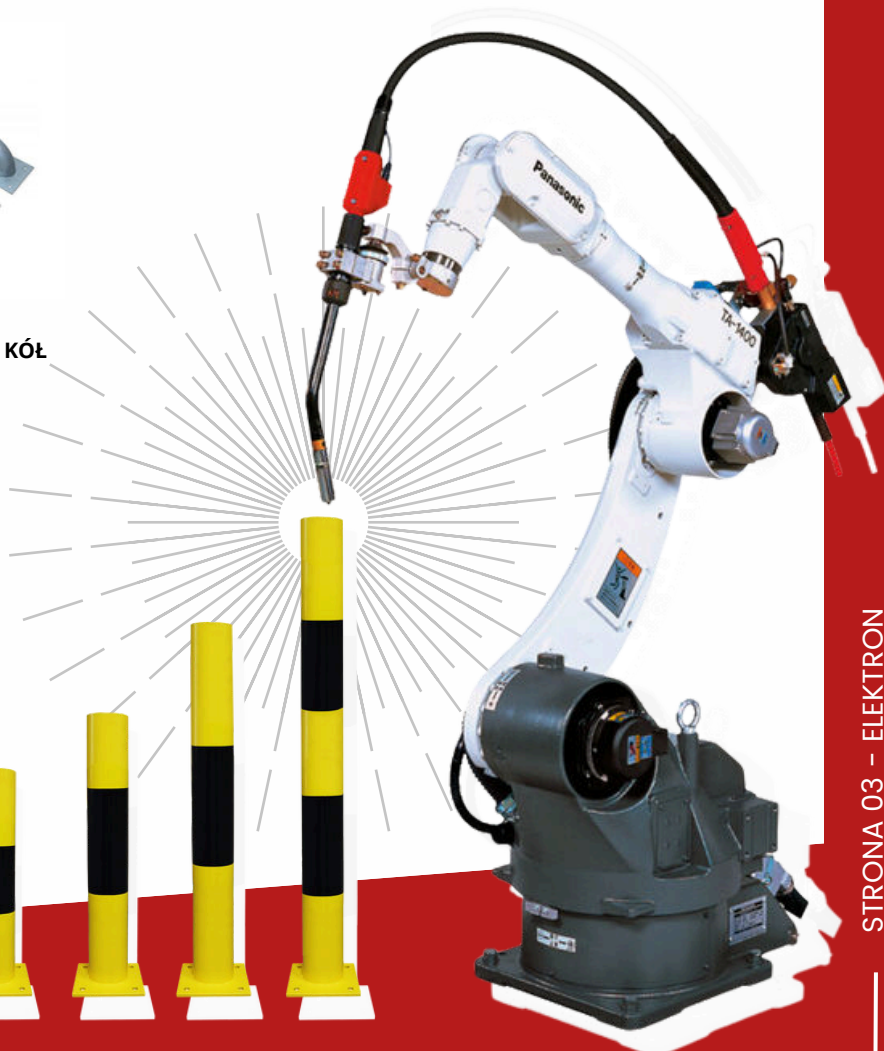

Produkowane przez nas odbojnice **zaczynają się od średnicy  $\varnothing 42,4$** . Odbojnice są specjalnie zaprojektowane do ochrony drzwi, narożników i sprzętu, zapewniając jednocześnie wysoką widoczność. Odbojnice te są pokryte warstwą cynku i pomalowane na jaskrawożółty kolor w celu zapewnienia maksymalnej widoczności. Dodatkowe czarne paski jeszcze bardziej zwiększają ich widoczność.

**Oferujemy również niestandardowe odbojnice dostosowane do Twoich potrzeb. Skontaktuj się z nami, jeśli potrzebujesz słupków o innych rozmiarach, materiałach, kolorach lub wzorach.**

#### Kluczowe cechy naszych odbojnic

- Materiał: czarna stal
- Powłoka: Ocynkowana ogniowo i malowana proszkowo na kolor żółty z czarnymi pasami lub dla zastosowań wewnętrznych tylko malowana metodą proszkową na kolor żółty z czarnymi pasami odbłaskowymi
- Montaż: mocowanie do podłoża za pomocą śrub lub kotew
- Grubość podstawy: 6-15 mm

## ODBOJNICE SŁUPOWE

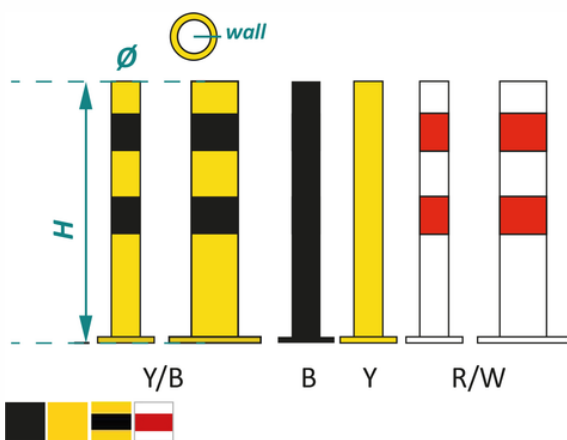

	$\varnothing$ (mm)	H (mm)
SB01	48,3	300,600,800, 900,1000,1200
SB02	60,3	
SB03	76,1	
SB04	114,3	
SB05	159	
SB06	219,1	

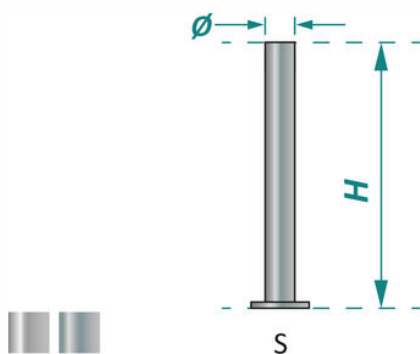

## ODBOJNICE SŁUPOWE INOX

	$\varnothing$ (mm)	H (mm)
SSB01	42,4	250
SSB02	42,4	500
SSB03	42,4	800



# ODBOJNICE LINIOWE

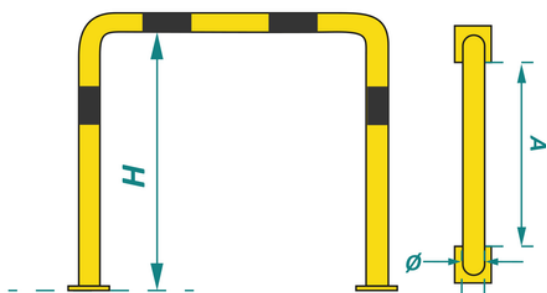

TP-L

	Ø (mm)	H (mm)	A (mm)
TP-L01	42,4	600,800,1000,1200	400,500,600,700, 800,900, 1000,1200, 1500,2000
TP-L02	48,3		
TP-L03	60,3		
TP-L04	76,1		

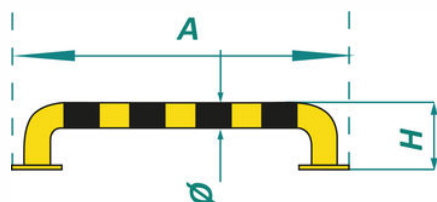

TP-S

	Ø (mm)	H (mm)	A (mm)
TP-S01	48,3	180, 220, 300, 400	300,350,400,450, 500,600,800,1000, 1200,1500,2000, 3000
TP-S02	60,3		
TP-S03	76,1		
TP-S04	114,3		

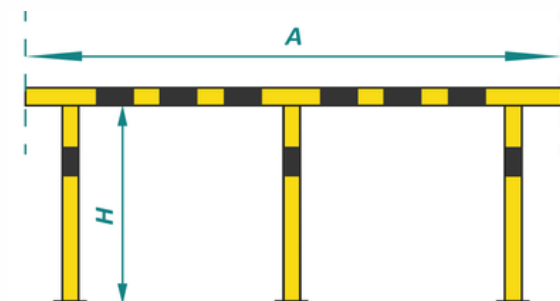

TP-H

	Ø (mm)	H (mm)	A (mm)
TP-H01	48,3	600,800, 1000,1200	300,350,400,450, 500,600,800,1000, 1200,1500,2000, 3000
TP-H02	60,3		
TP-H03	76,1		
TP-H04	114,3		

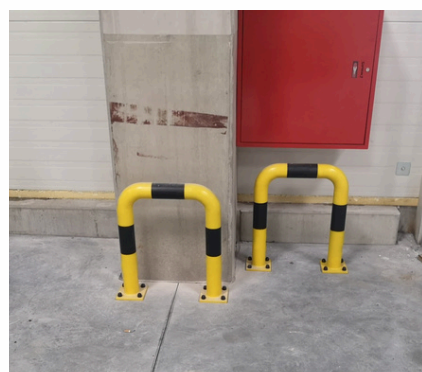

## ODNOJNICE PRZYPODŁOGOWE

## SFS - Odbojnica liniowa

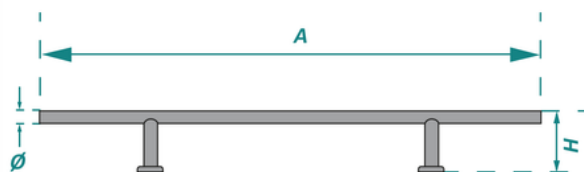

	Ø (mm)	H (mm)	A (mm)
SFS01	42,4	180	400, 500, 600, 1200, 1600
SFS02			
SFS03			
SFS04			

## CFS - Odbojnica narożna

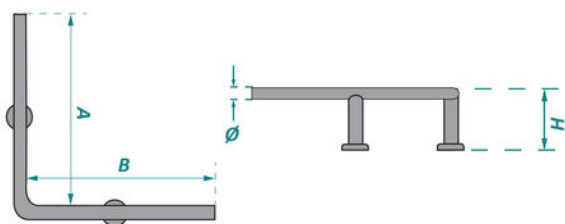

	Ø (mm)	H (mm)	A (mm)	B (mm)
CFS01	42,4	180	400	400
CFS02	42,4	180	600	600

## BARIERKI TECHNICZNE

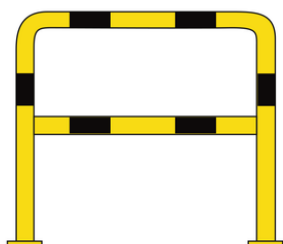

## (DH) - Standardowa barierka techniczna

	Ø (mm)	H (mm)	A (mm)
DH01	42,4	600, 800, 1000, 1200	400, 500, 600, 700, 800, 900, 1000, 1200, 1500, 2000
DH02	48,3		
DH03	60,3		
DH04	76,1		

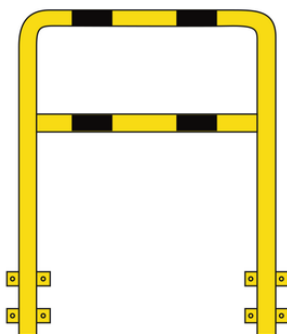

## (F-DH) - Barierka techniczna z mocowanie do ściany

	Ø (mm)	H (mm)	A (mm)
F-DH01	42,4	600, 800, 1000, 1200	400, 500, 600, 700, 800, 900, 1000, 1200, 1500, 2000
F-DH02	48,3		
F-DH03	60,3		
F-DH04	76,1		



## ODBOJNICE NAROŻNE

(L-1) - Odbojnica kwadratowe - dwie stopy na rogu

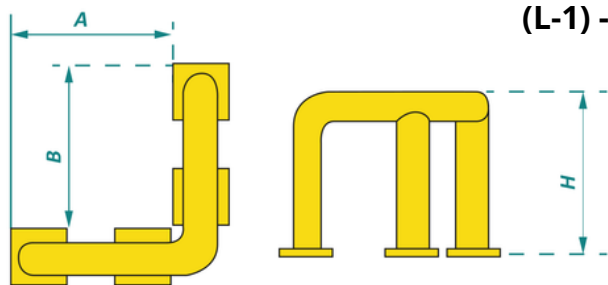

	Ø (mm)	H (mm)	A=B (mm)
L-101	42,4	300,600,800, 1000,1200	300,400,500, 600,700,800, 900,1000,1200 1500
L-102	48,3		
L-103	60,3		
L-104	76,1		

(L-2) - Odbojnica prostokątna - dwie stopy na rogu

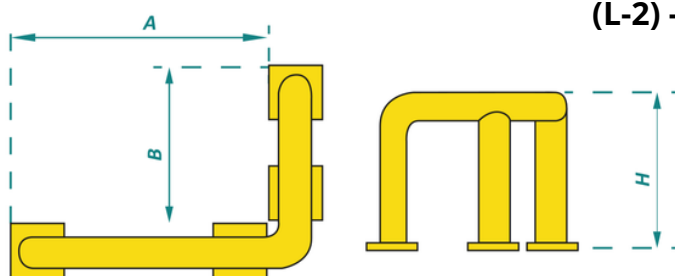

	Ø (mm)	H (mm)	A (mm)	B (mm)
L-201	42,4	300,600,800, 1000,1200	300,400,500, 600,700,800, 900,1000,1200 1500	300,400,500, 600,700,800, 900,1000,1200, 1500
L-202	48,3			
L-203	60,3			
L-204	76,1			

(L-3) - Odbojnica z jedną stopą na rogu

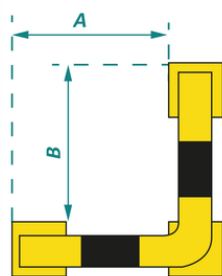

	Ø (mm)	H (mm)	A/B (mm)
L-301	42,4	300,600,800, 1000,1200	300,400,500, 600,700,800, 900,1000,1200 1500
L-302	48,3		
L-303	60,3		
L-304	76,1		

## ODBOJNICE W KSZTAŁCIE LITERY U

(U-1) - Odbojnice na 2 nogach



	Ø (mm)	H (mm)	A (mm)	B (mm)
U-101	42,4	300,600,800, 1000,1200	300,400,500, 600,700,800, 900,1000,1200 1500	300,400,500, 600,700,800, 900,1000,1200 1500
U-102	48,3			
U-103	60,3			
U-104	76,1			

(U-2) - Odbojnice na 3 nogach

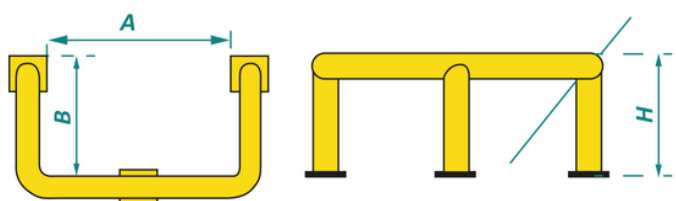

	Ø (mm)	H (mm)	A (mm)	B (mm)
U-201	42,4	300,600,800, 1000,1200	300,400,500, 600,700,800, 900,1000,1200 1500	300,400,500, 600,700,800, 900,1000,1200 1500
U-202	48,3			
U-203	60,3			
U-204	76,1			

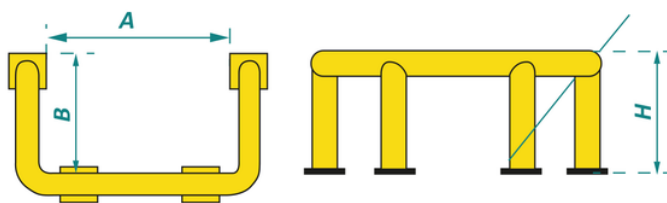

### (U-3) - Odbojnice na czterech nogach

	Ø (mm)	H (mm)	A (mm)	B (mm)
U-301	42,4	300,600,800, 1000,1200	300,400,500, 600,700,800, 900,1000,1200 1500	300,400,500, 600,700,800, 900,1000,1200 1500
U-302	48,3			
U-303	60,3			
U-304	76,1			



### OSŁONY KOLUMN

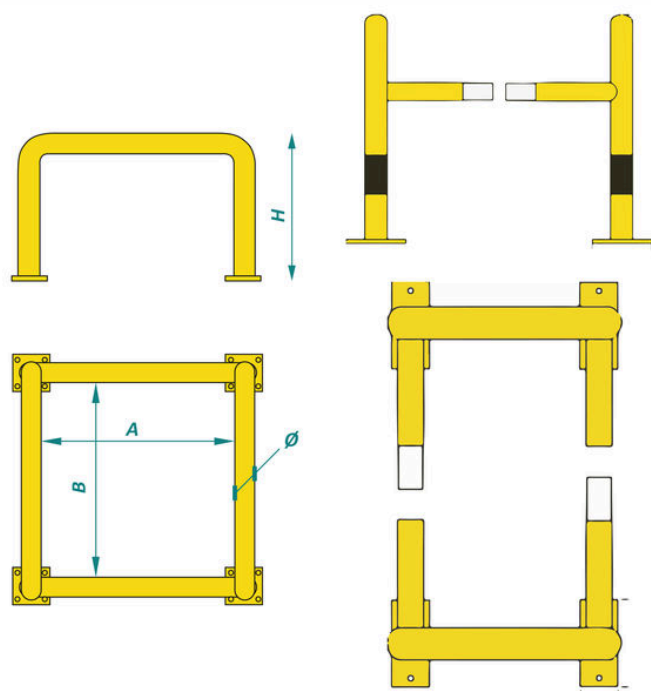

	Ø (mm)	H (mm)	A=B (mm)
CPP-01	42,4	600,800, 1000,1200	600,800,1000
CPP-02	48,3		
CPP-03	60,3		
CPP-04	76,1		





## OGRANICZNIKI PRZYPODŁOGOWE

### (CPB) - Liniowy ogranicznik przypodłogowy

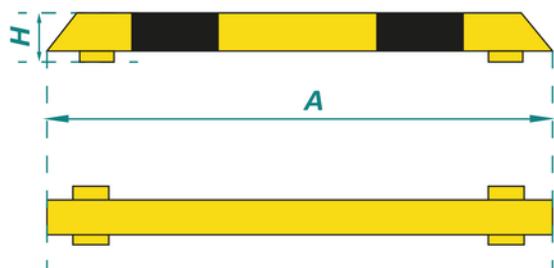

	Ø (mm)	A (mm)
CPB-101	42,4	300,600,800,1000,1200
CPB-102	48,3	
CPB-103	60,3	
CPB-104	76,1	



## OSŁONY REGAŁÓW

### (RG-PR) - Osłony w kształcie litery L.

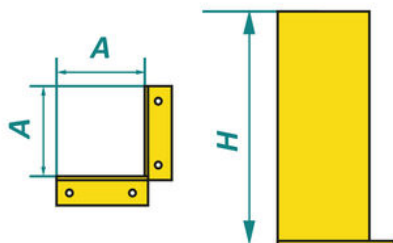

	H (mm)	A (mm)
RG-PR	400,500,600, 800,1000,1500	300,600,800, 1000,1200

### (UP-PR) - Osłony w kształcie litery U.

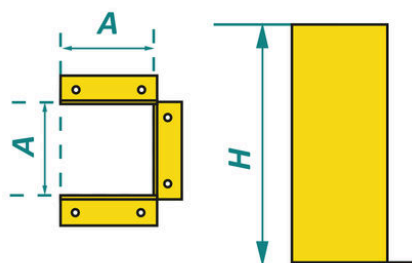

	H (mm)	A (mm)
UP-PR	400,500,600, 800,1000,1500	300,600,800, 1000,1200



## NAPROWADZACZE KÓŁ

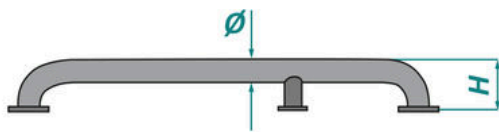
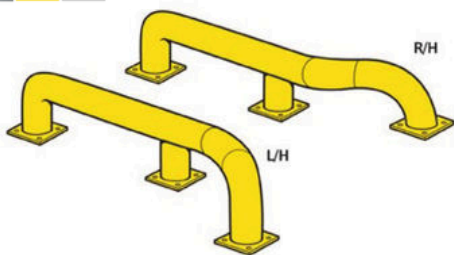
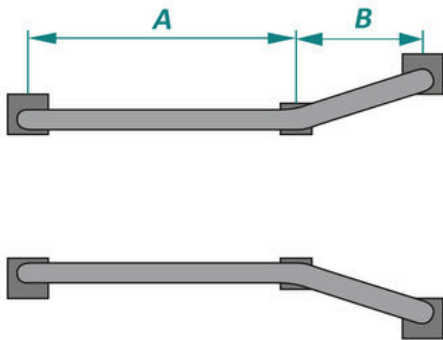

(WG)

	$\varnothing$ (mm)	H (mm)	A+B (mm)
WG01	76,1	300	1500,2000, 2500,3000
WG02	114,3		
WG03	159		



## OGRANICZNIKI WYSOKOŚCI

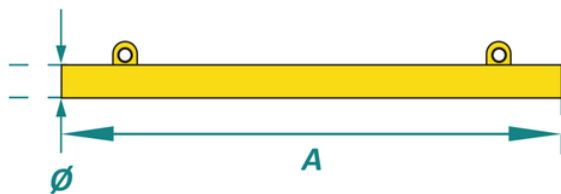

(HL)

	$\varnothing$ (mm)	A (mm)
HL01	42,4	500,1000,1500, 2000,2500,3000
HL02	48,3	
HL03	60,3	



ELEKTRON SP. Z O.O.

# TWÓJ DOSTAWCA ODBOJNIC PRZEMYSŁOWYCH



Sulistrowa 33, 38-462  
Poland



biuro@web-elektron.pl



(+48) 13 307 03 03

webelektron.pl